

Imminent Collapse of Internet

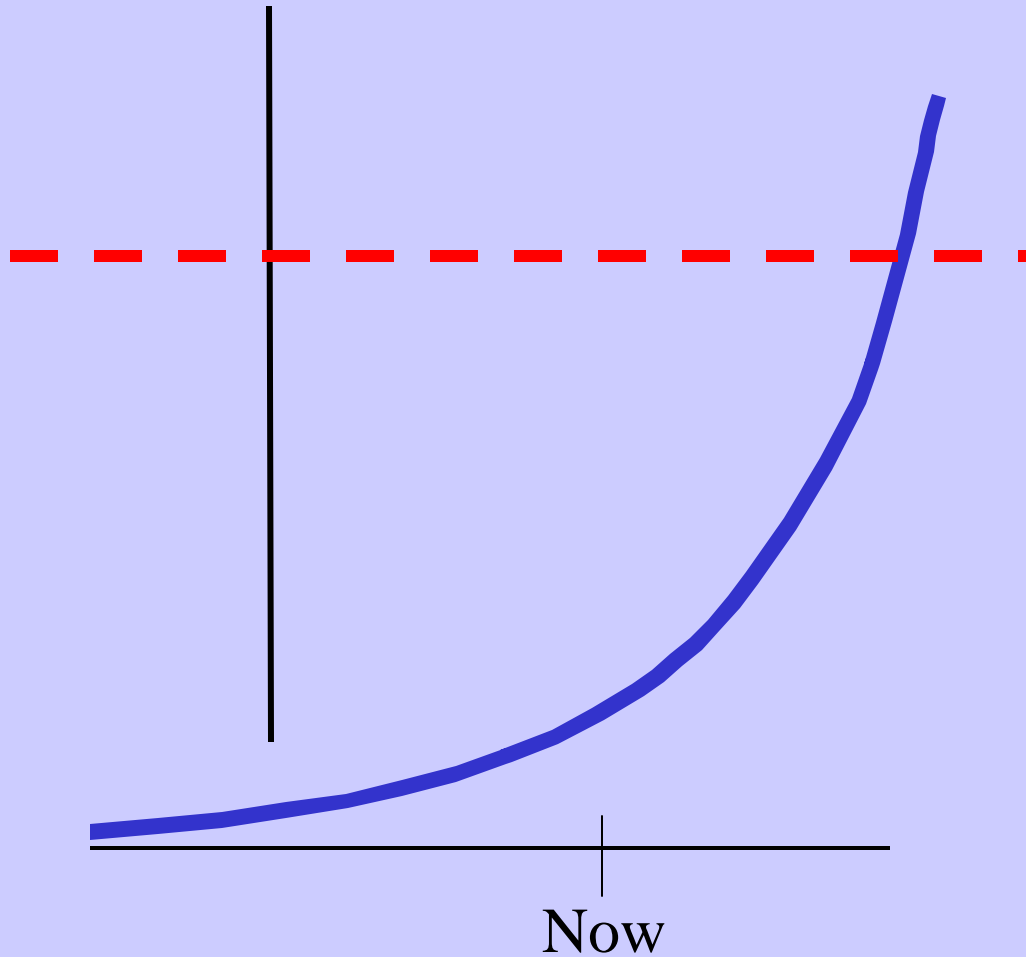

**END OF
INTERNET**

Slide thanks
to Abha Ahuja
(who meant it
as a parody)

The End is in Sight!

“The existing interdomain routing infrastructure is **rapidly** nearing the end of its useful lifetime.”

-- *widely* distributed email by an IAB member

“The IETF has admitted the internet has failed” -- Circuit-zilla

Death of Internet Predicted

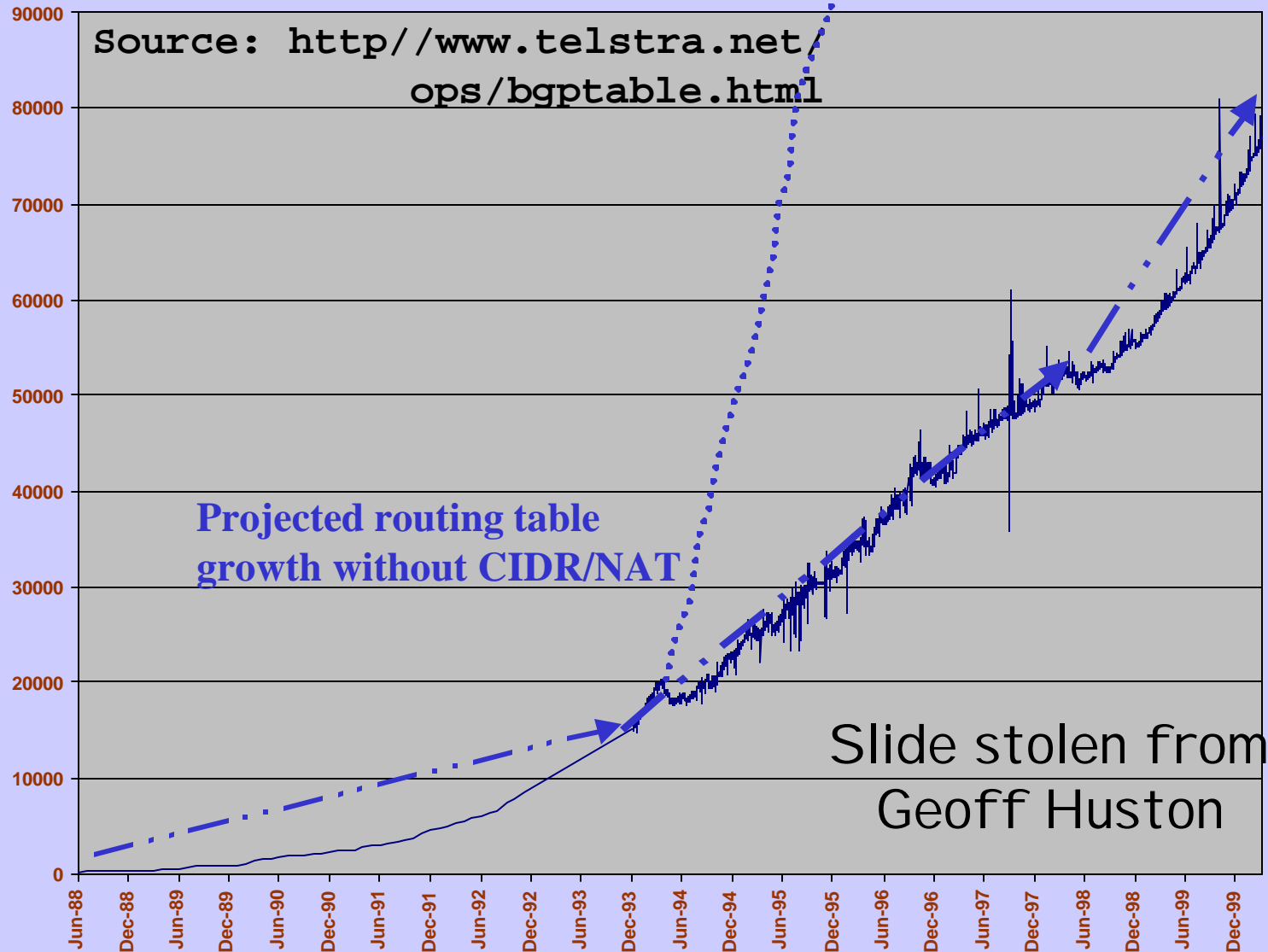

News at Eleven

Routing Issues
RIPE40 / Praha
2001.10.04

Randy Bush <randy@bellhead.com>
Steve Bellovin <smb@wilyhacker.com>
Tim Griffin <griffin@research.att.com>
Jennifer Rexford <jrex@research.att.com>

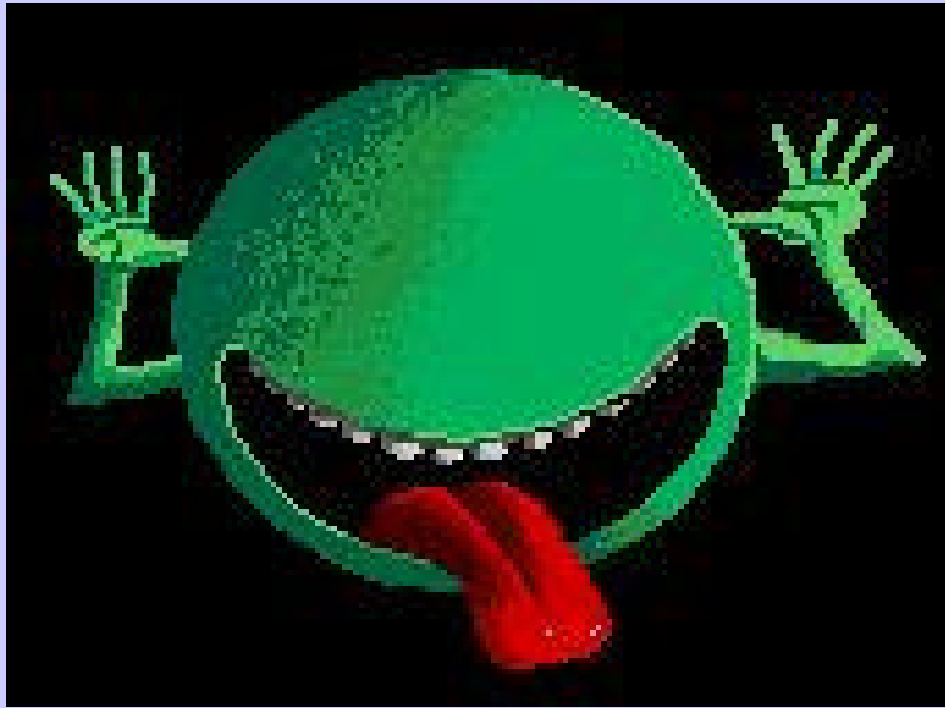

Don't Panic,

Engineer Prudently

The Simple Life

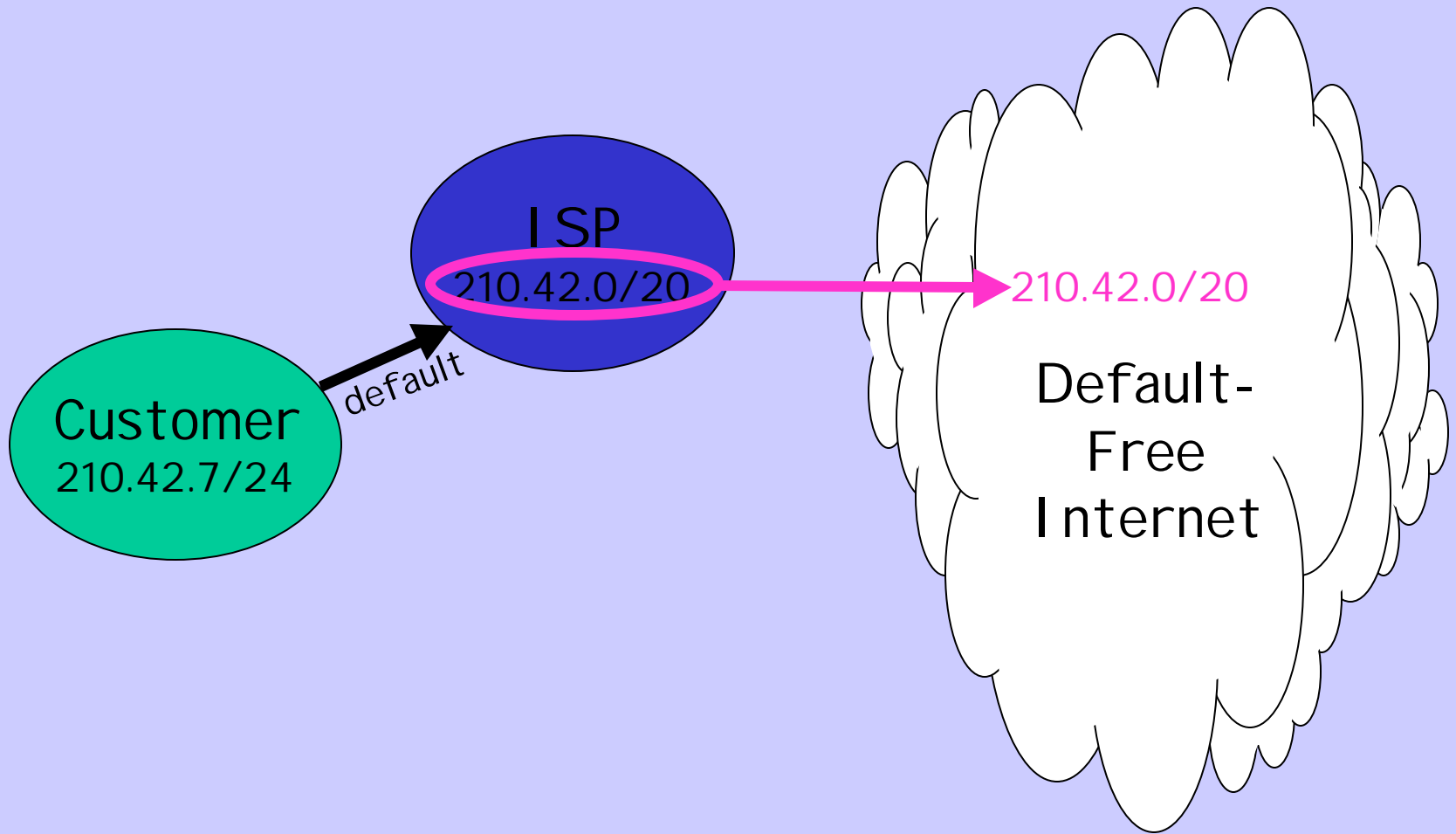

The Problem of Multihoming

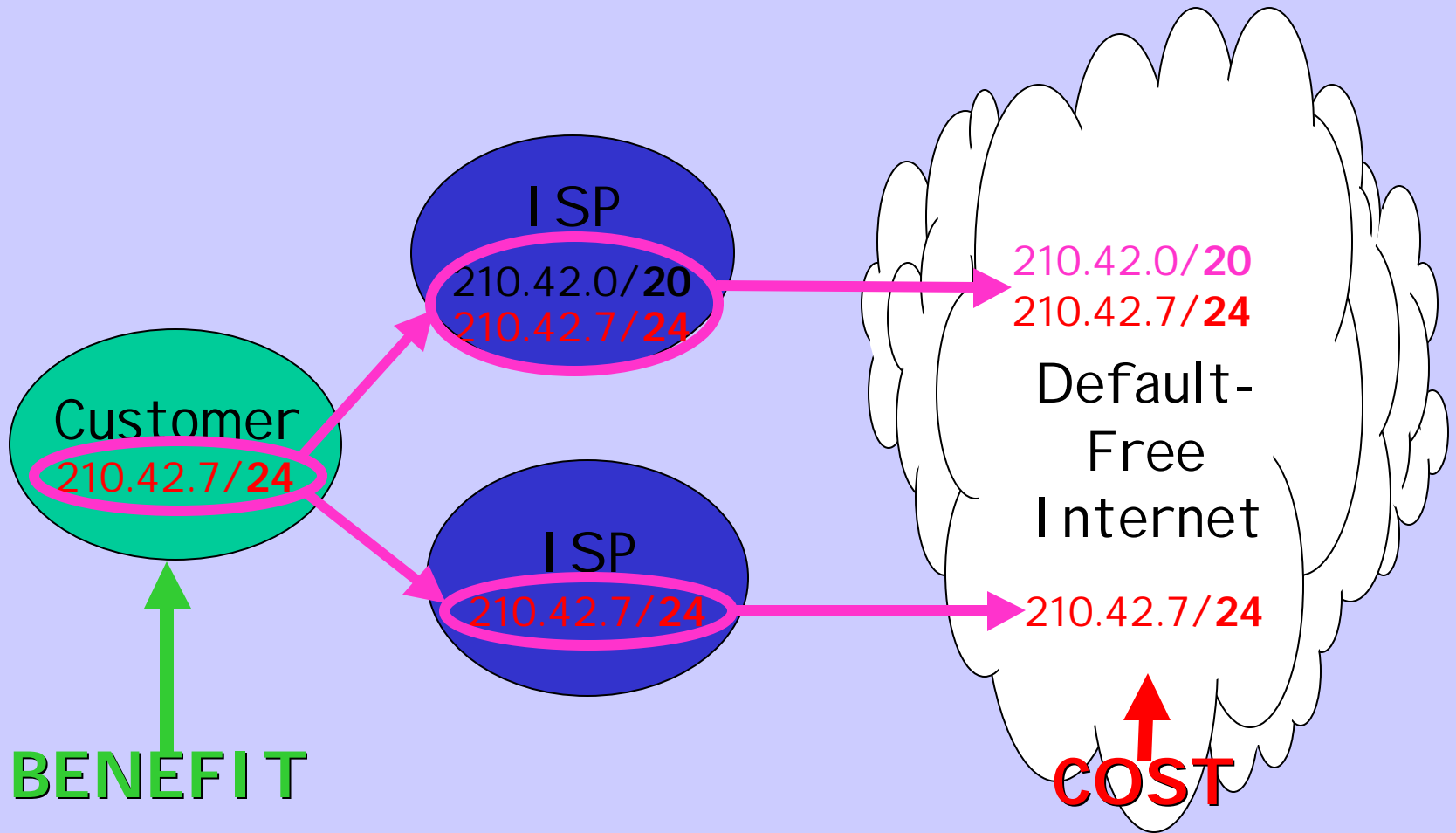

Grazing the Commons

Prolonging the Current Commons

- A major problem is the DFZ (default-free internet) is being flooded with many small announcements of multi-homers
- We need at least five+ years to design, develop, & deploy a new routing paradigm
- So what would be the effect if peers stopped listening to those long prefixes?
- What happens if we filter announcements from peers on RI R allocation boundaries?

Allocation Boundaries (RIPE)

ripe-222

Block	Default	Smallest
62/8	/19	/19
80/8	/20	/20
81/8	/20	/20
193/8	/19	/29
194/8	/19	/29
195/8	/19	/29
212/8	/19	/19
213/8	/19	/19
217/8	/20	/20

Worldnet (1) at Route-Views

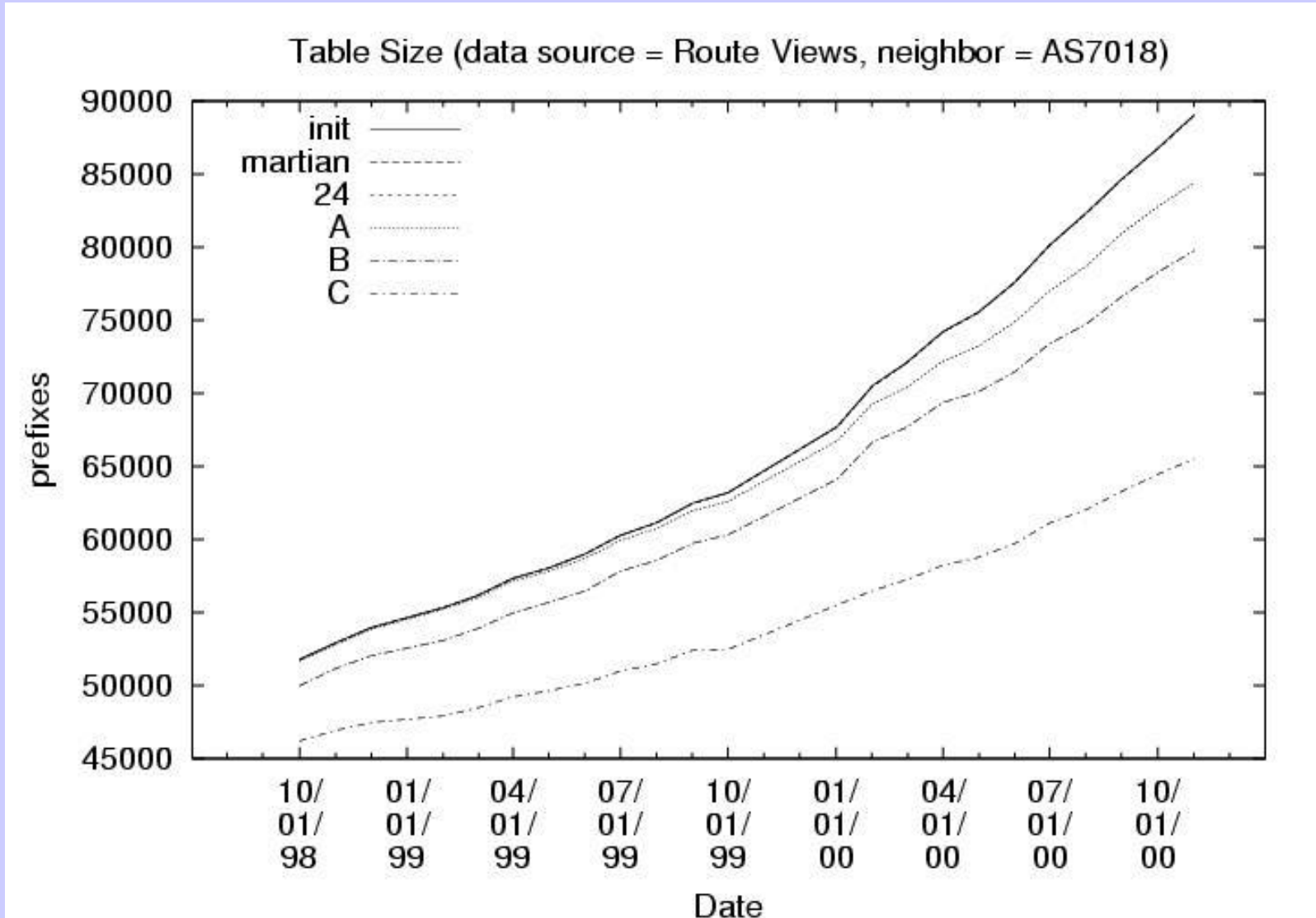

Worldnet (2) at Route-Views

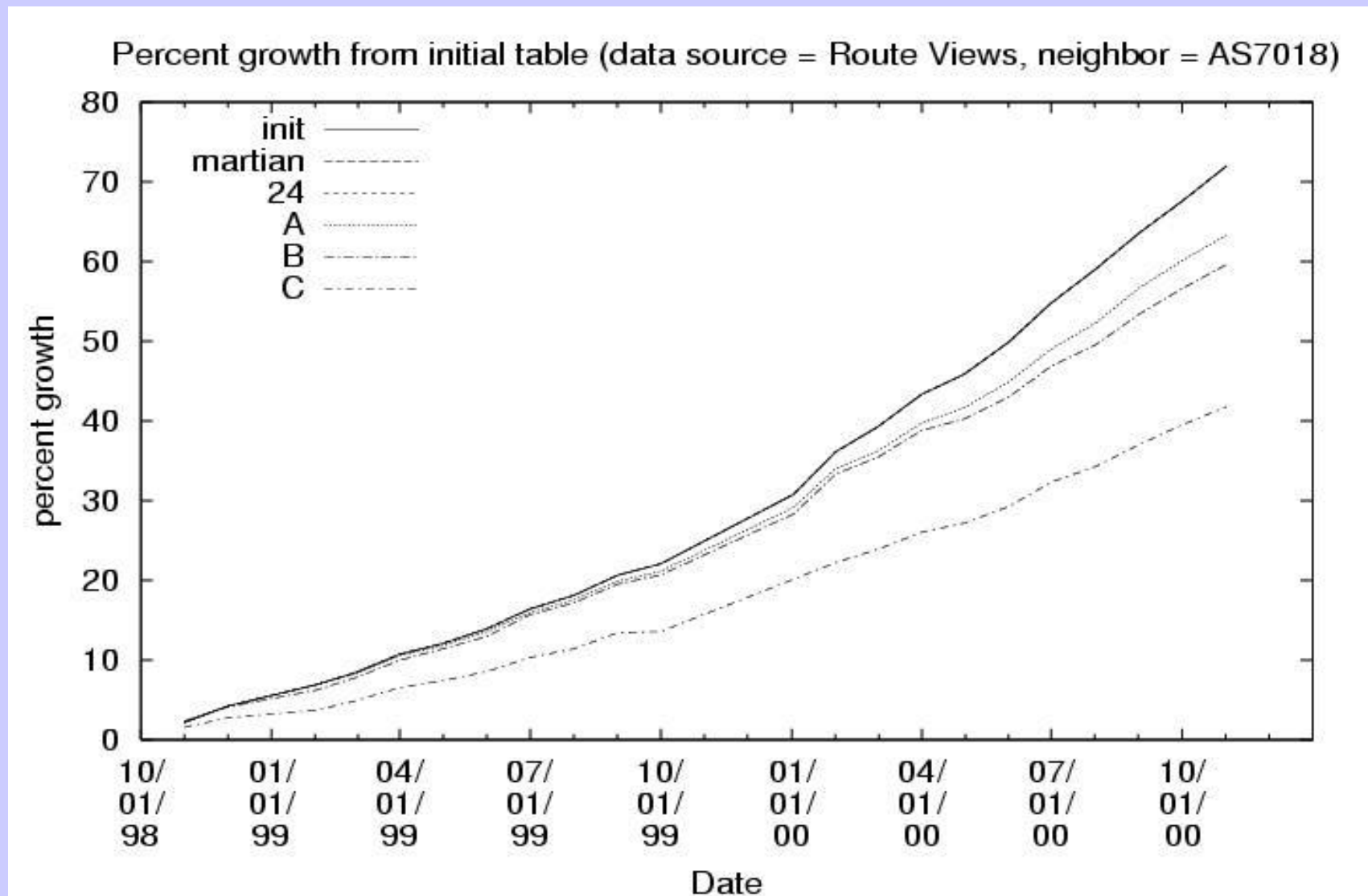

Worldnet (3) at Route-Views

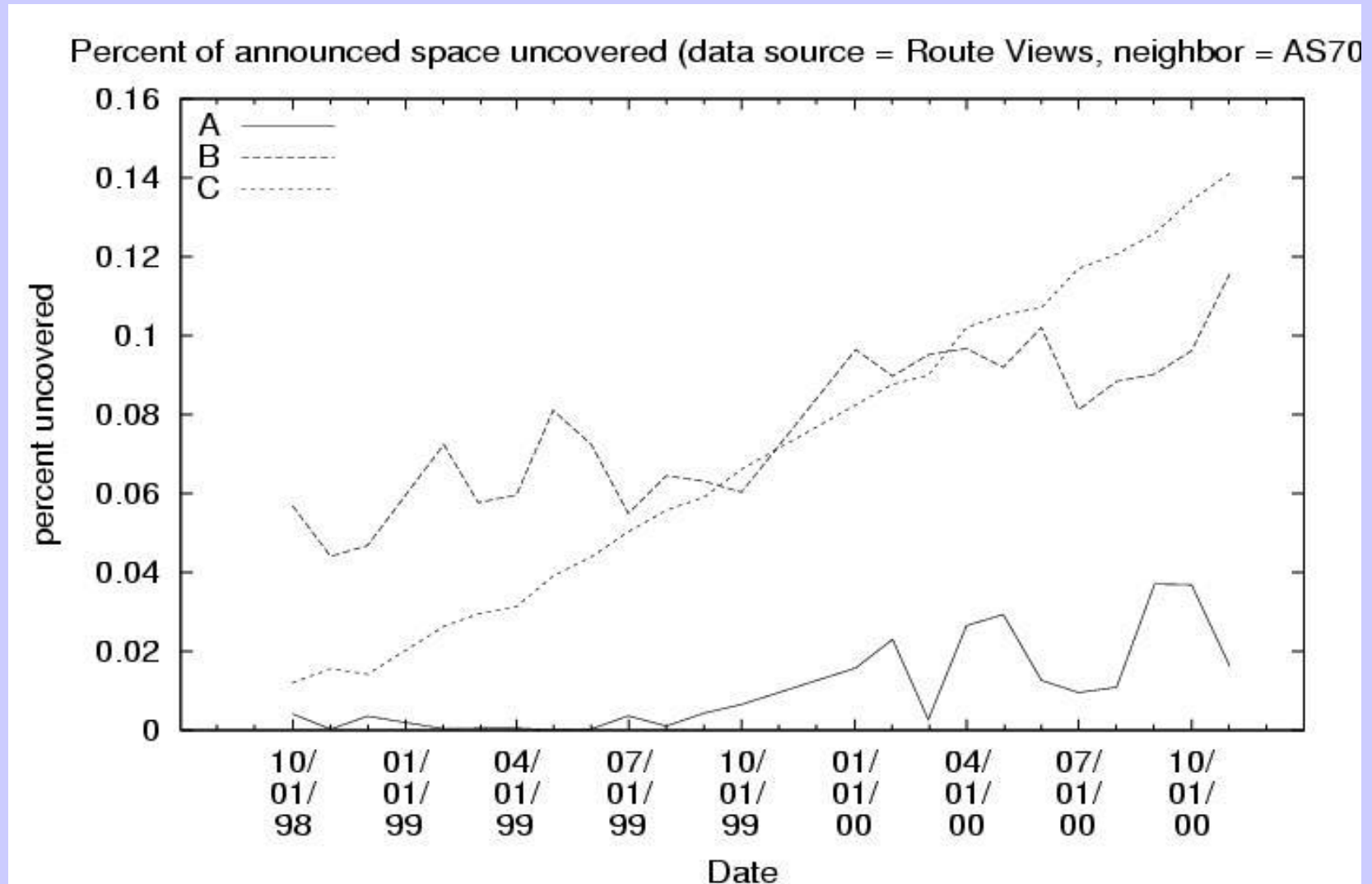

C&W (1) at Route-Views

Table Size (data source = Route Views, neighbor = AS3561)

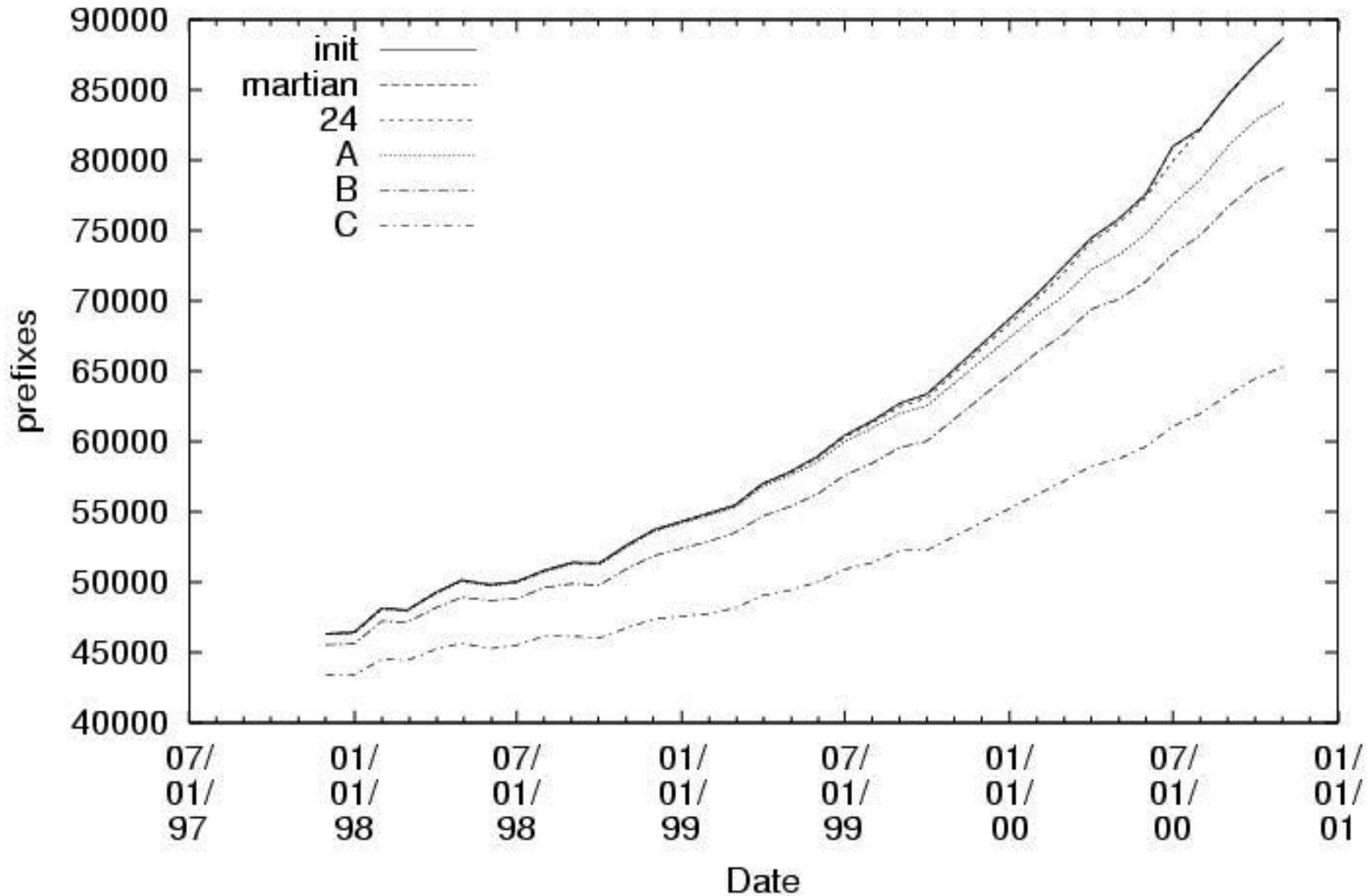

C&W (2) at Route-Views

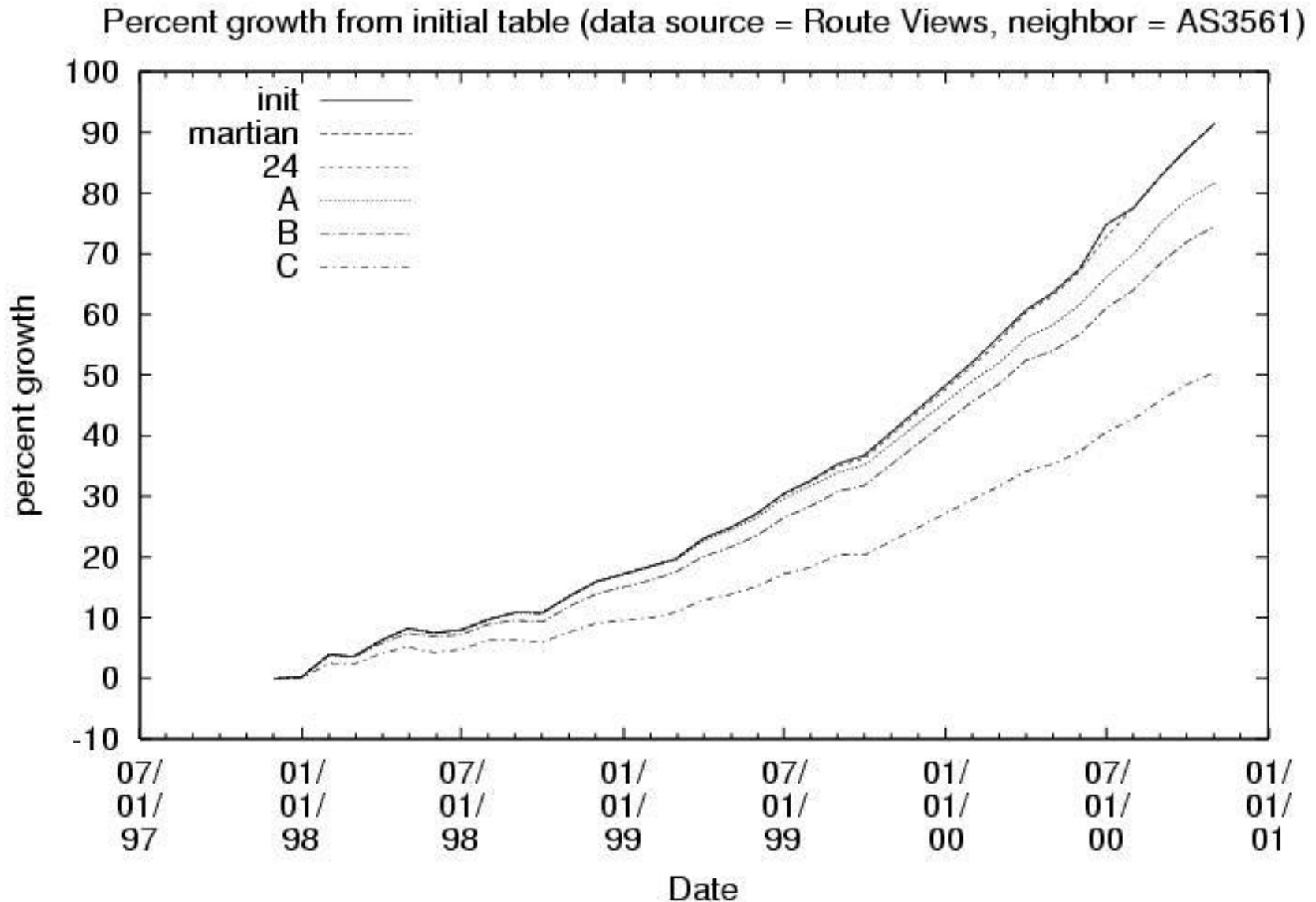

C&W (3) at Route-Views

Percent of announced space uncovered (data source = Route Views, neighbor = AS35)

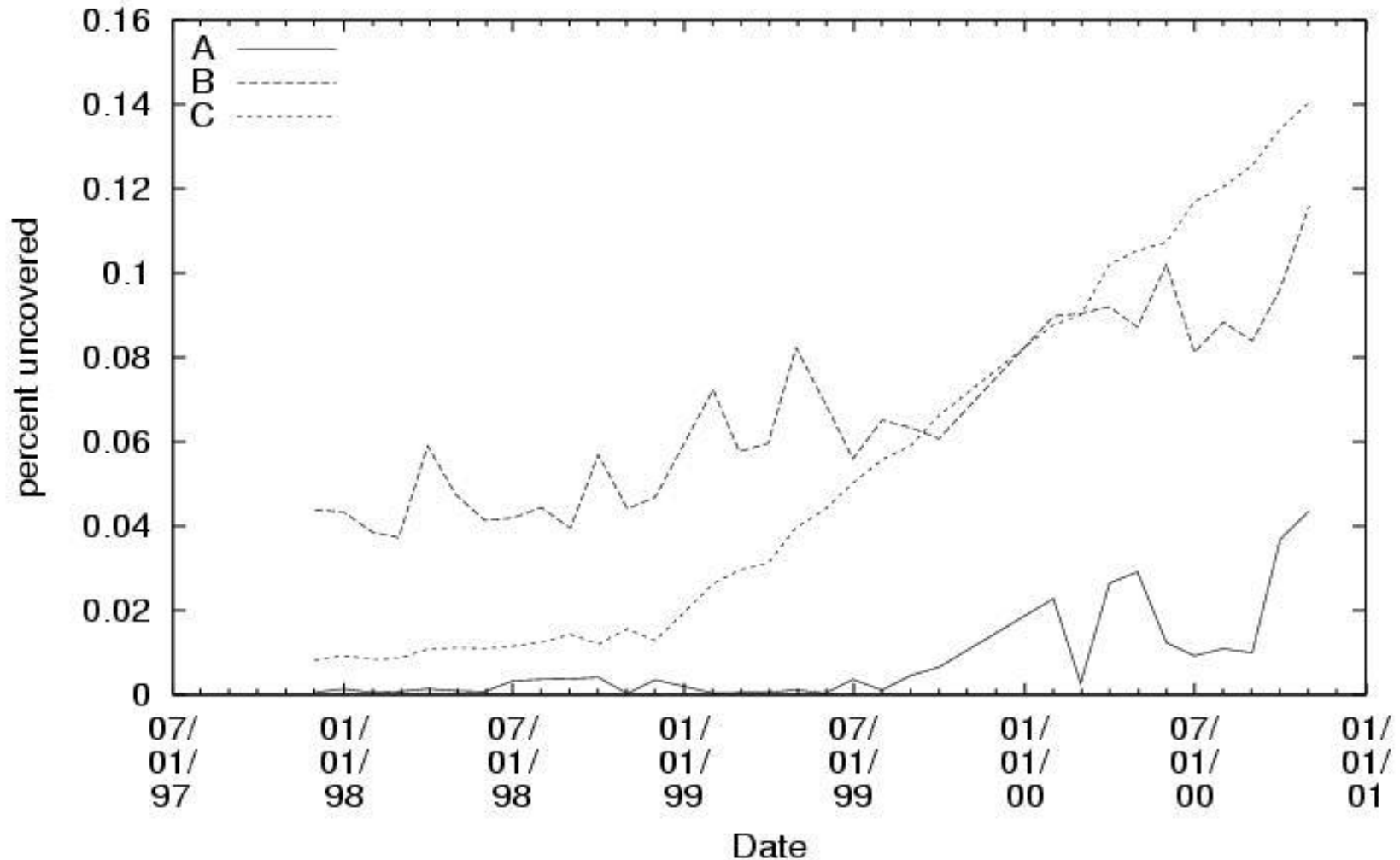

Sprint (1) at Route-Views

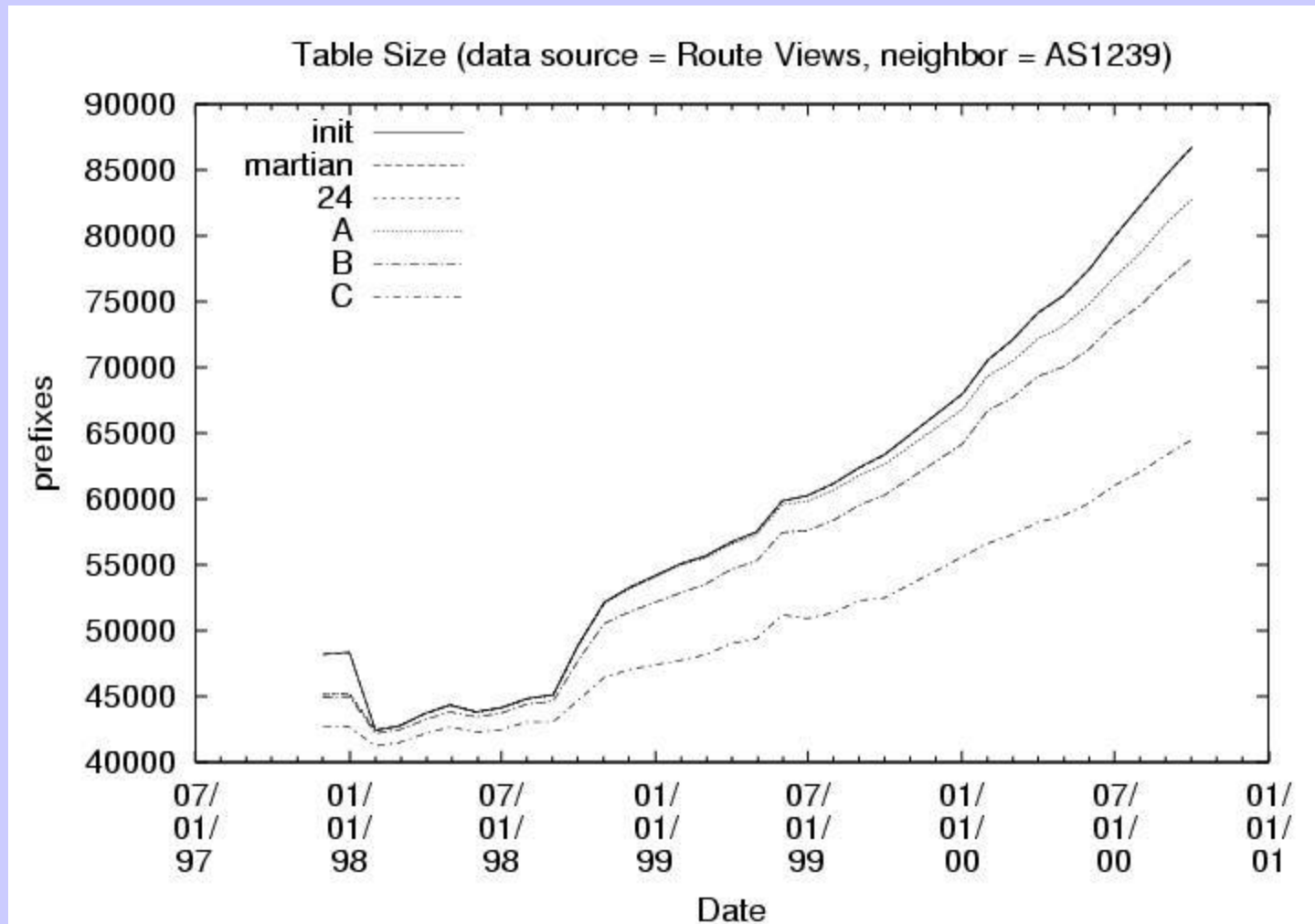

Sprint (2) at Route-Views

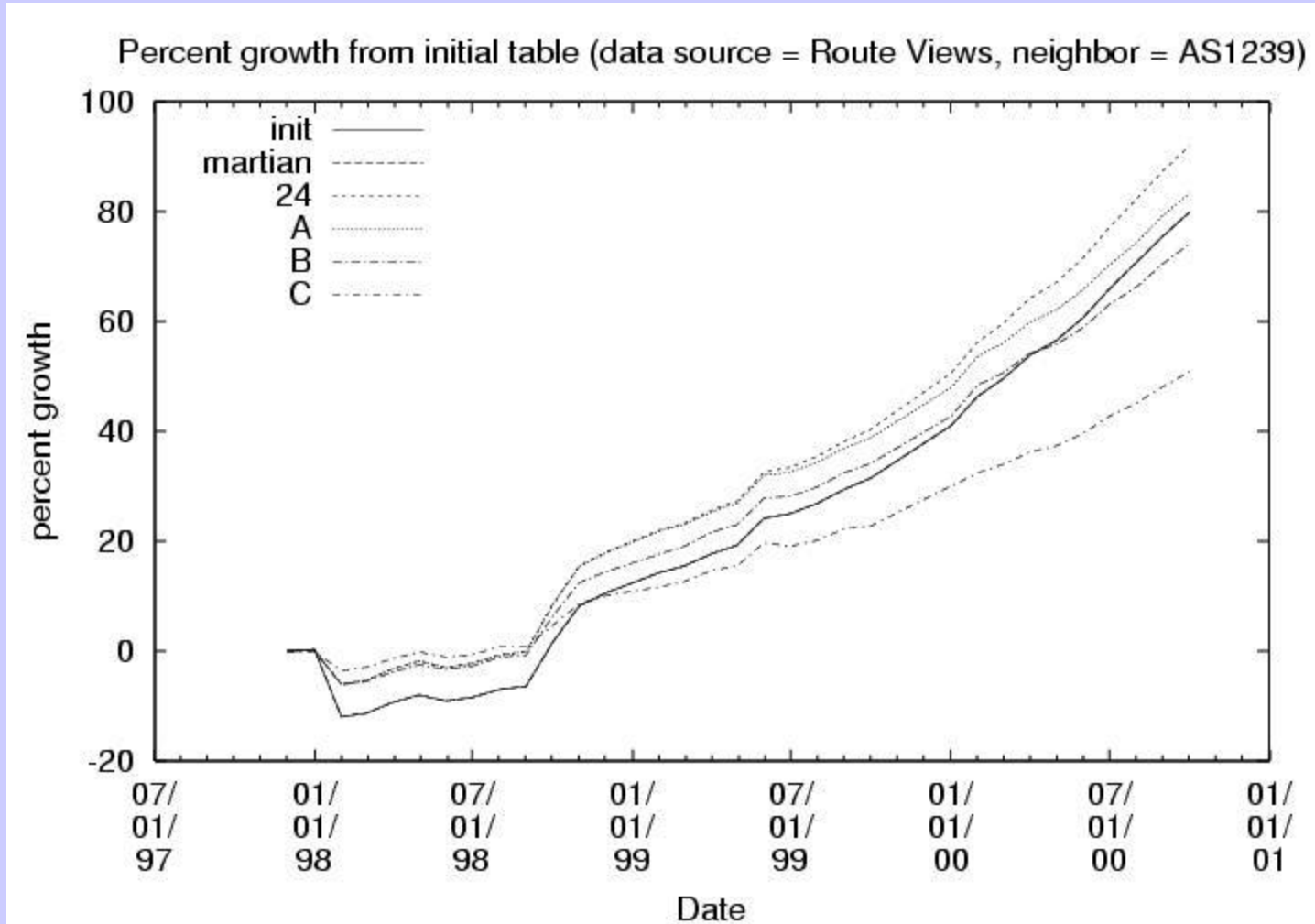

Sprint (3) at Route-Views

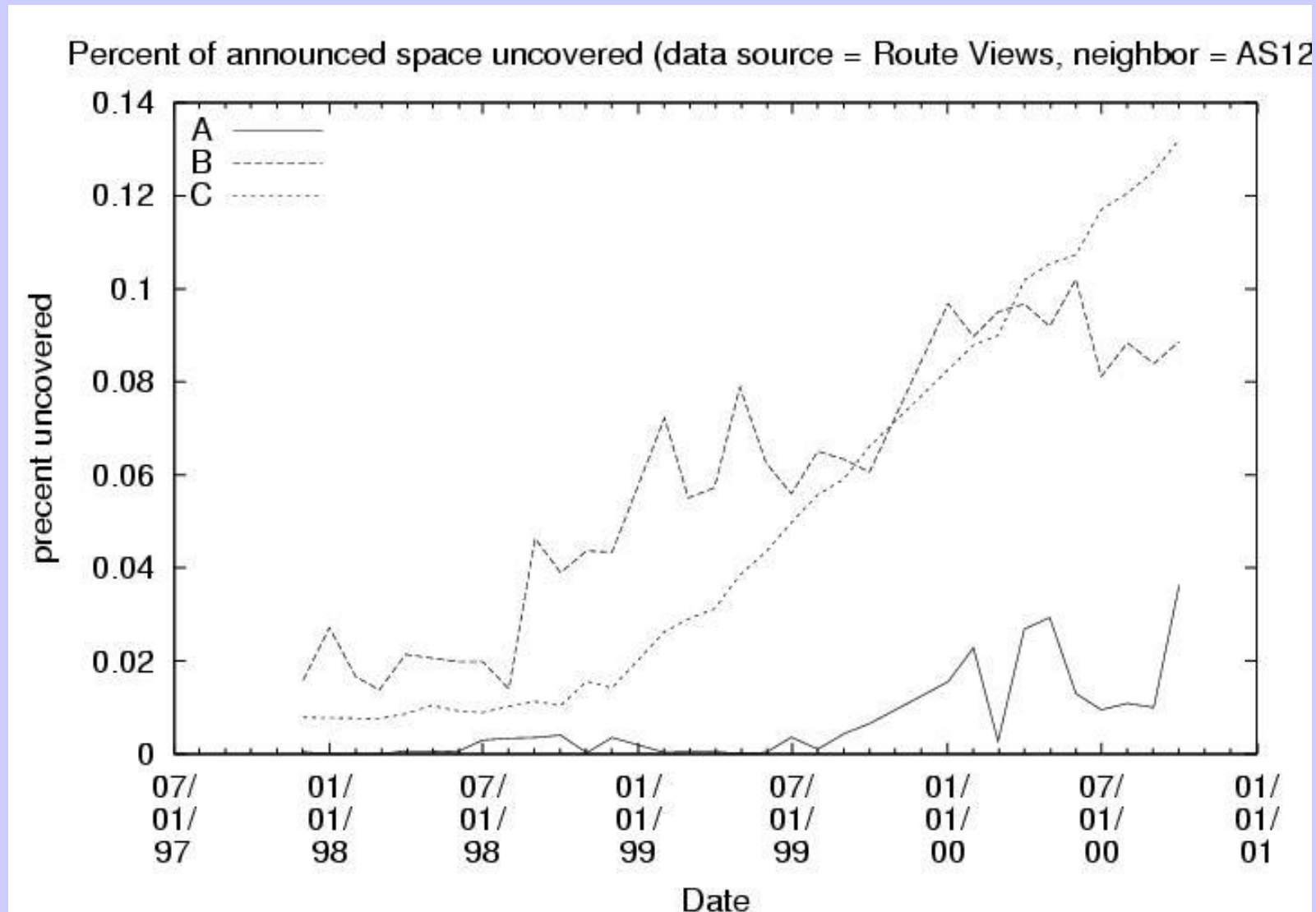

So How Long?

- If all v4 space is announced as /20s (very pessimistic) $2^{20} = 1,048,576$
- At recent allocation (not announcement) rates, that's 2010++ and a million prefixes
- This is three doublings in 9+ years, i.e. well under Moore's Law
- And we will be at the end of the v4 space

Cumulative IPv4 Allocations

Cumulative IPv4 Addresses Allocated

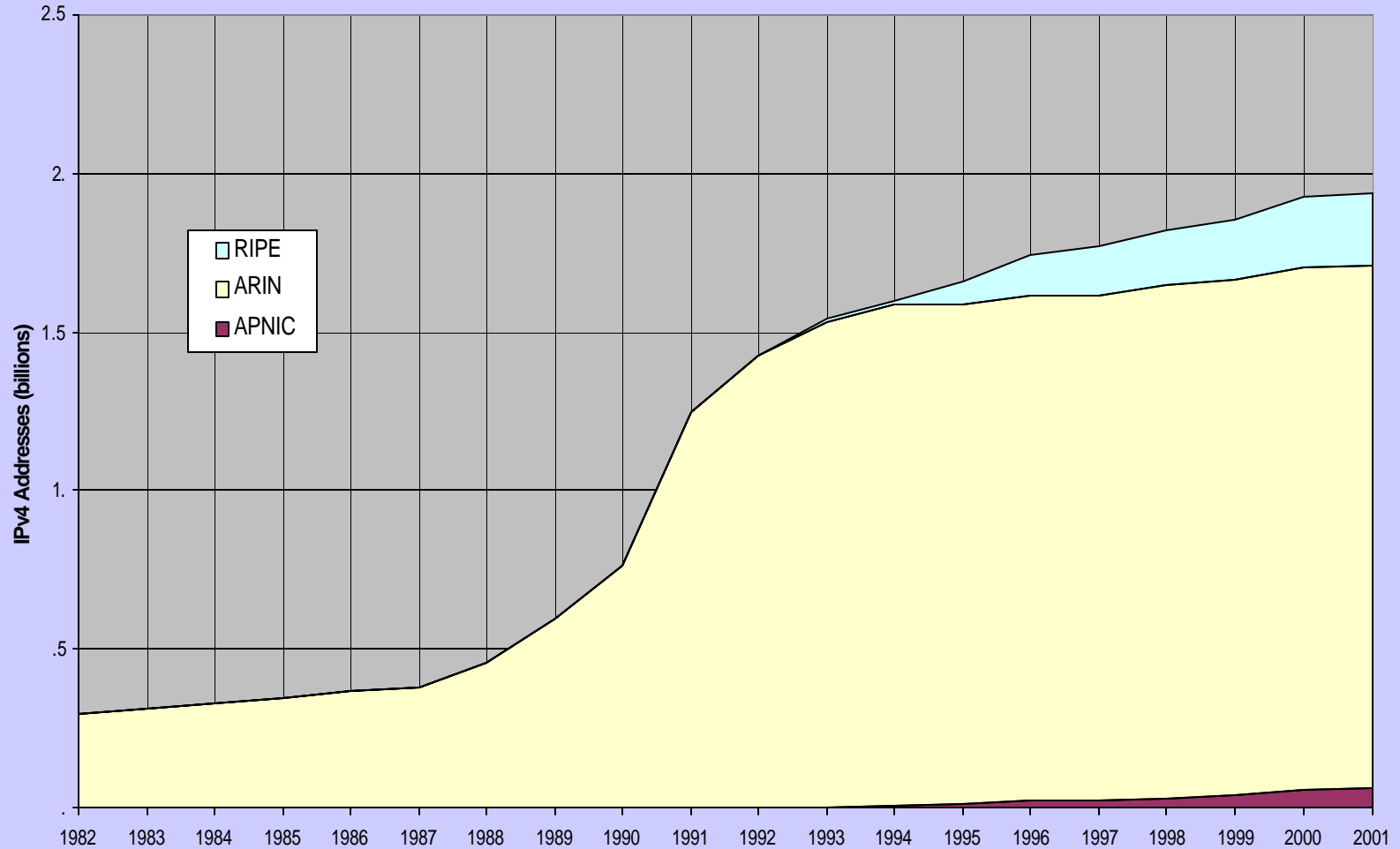

Stolen from Scott Marcus

I Pv4 Allocations: Linear Fit

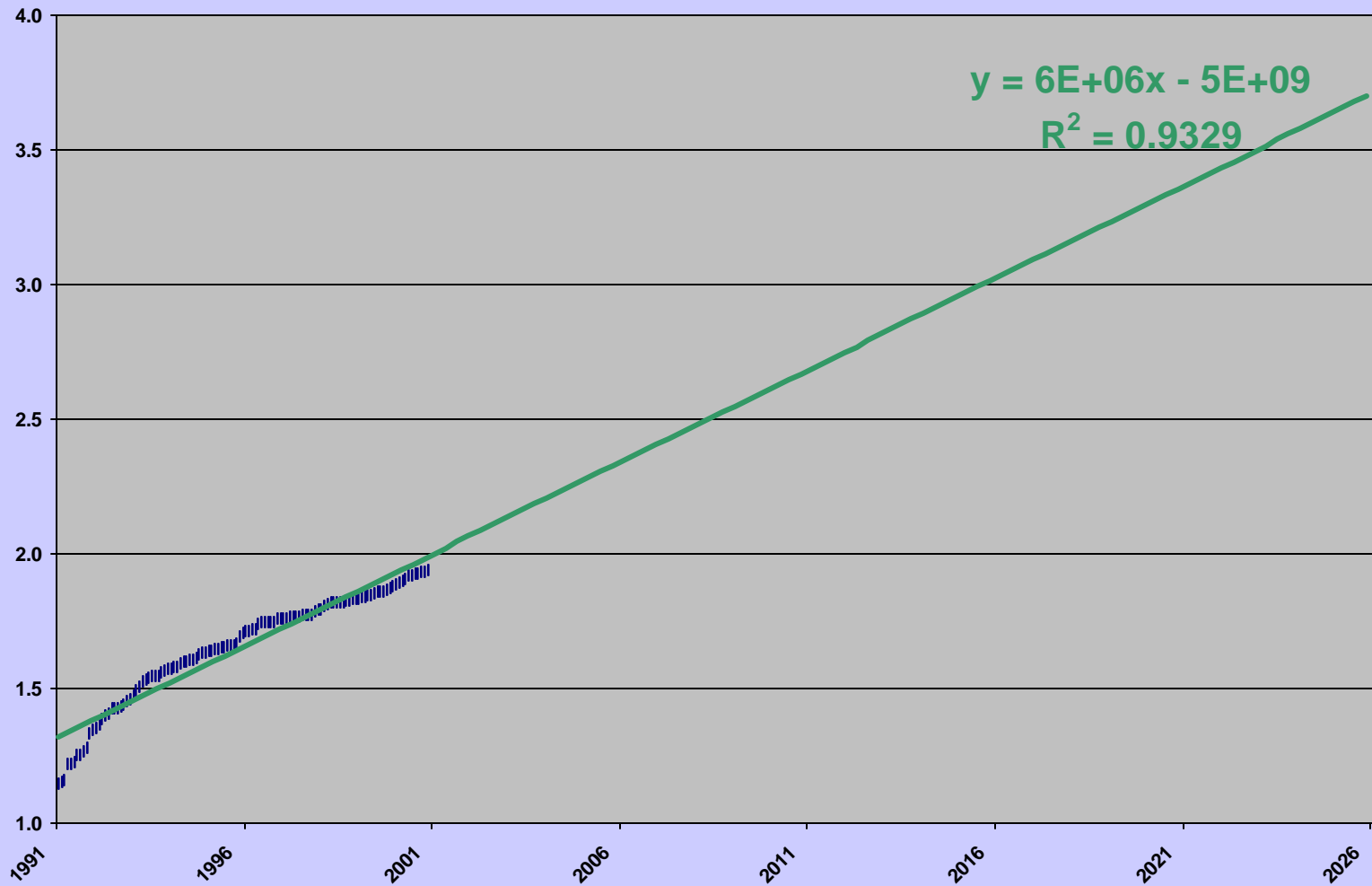

Stolen from Scott Marcus

I Pv6 != Silver Bullet

- I Pv6 gives us a lot more address space
- So the allocation curve continues
- But I Pv6 does not yet have new routing or multi-homing paradigms
- I Pv6 without a routing paradigm change exacerbates the routing problem!
- This is not new news
- multi6 and ptomaine are working on the short-term stall
- I RTF rrg and others for the long-term

Conclusion

- Rumors of the Imminent Death of the Internet have been greatly exaggerated (remember the address space panic in '93-'94?)
- Prudent operational practice can continue to keep us going for well over five years
 - Filtering
 - BGP tweaks
- But, as prudent engineers, we, the IETF, **must** spend this window developing a new routing paradigm. And time's a wastin'!

Fun Things to Do

- IETF ptomaine WG <ptomaine@shrubbery.net>
 - more detailed data from this study
 - completely independent research group comes to similar conclusion
 - discuss some knobs and hacks to do all this
- Operators, filter please
- Tell your friends
- <http://psg.com/~randy/011004.ripe.pdf>
- [http://www.research.att.com/~jrex/papers/filter.\(pdf|ps\)](http://www.research.att.com/~jrex/papers/filter.(pdf|ps))